

ECLIPSE AIR HEAT BURNERS

Series "RAH" & "TAH-R" For Recirculating Air

U.S. Reissue Pat. No. 26,244 Canadian Pat. No. 743,782



RAH, Front View
Data 142-1

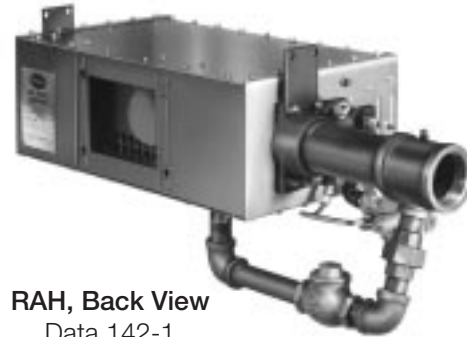

RAH, Back View
Data 142-1



TAH-R, Front View
Data 142-2



TAH-R, Back View
Data 142-2

Eclipse "RAH" and "TAH-R" Air Heat Burners are line type burners ideal for generating large volumes of clean, hot air. Combustion air is supplied by a combustion air blower located outside the duct. This allows the burners to operate in recirculating airstreams with air temperatures upstream of the burner as high as 750° F (400° C). Applications include ovens, dryers, fume incinerators, and similar industrial equipment.

Because combustion air is supplied to the burner from outside the duct, "RAH" and "TAH-R" burners provide stable operation over a wide range of duct velocities without installing a profile plate around the burner.

- Low NO_x, CO and aldehydes.
- Exceptional flame stability with duct velocities from 500 to 6000 fpm (2.54 to 30.48 m/s.)
- Recirculating air temperatures up to 750° F (400° C) upstream of the burner.
- No profiling required.
- Up to 40:1 gas turndown.
- Inputs up to 1,000,000 Btu/hr. per lineal foot of burner (962 kW/m)
- As little as 10% excess air at high fire; when mounted on the duct wall, no oxygen is required from the process airstream.
- Wide range of configurations, packages, and accessories.



ECLIPSE COMBUSTION

Specifications

Input:	1,000,000 Btu/hr. per lineal foot (962 kW/m).		
Fuels:	Natural gas or 100% propane vapor. Call Eclipse for information on using other fuels.		
Gas Turndown:	40:1		
Pilot Input:	Approximately 25,000 Btu/hr. (7.3 kW)		
Gas Inlet Pressure:	800,000 Btu/hr/ft. (769 kW/m):	Nat. Gas: 2.2" w.c.	5.5 mbar
		Propane: 0.9" w.c.	2.2 mbar
	1,000,000 Btu/hr/ft. (962 kW/m):	Nat. Gas: 3.5" w.c.	8.7 mbar
		Propane: 1.3" w.c.	3.2 mbar
Gas pressure shown is a differential measured between the gas inlet and a tap on the duct wall 10" to 20" (254 to 508 mm) downstream of the burner.			
Flame Length*:	800,000 Btu/hr. (769 kW/m):	28"	0.71 m
	1,000,000 Btu/hr. (962 kW/m):	46"	1.17 m
Piloting:	Integral spark-ignited pilot; ignition plug included.		
Flame Monitoring:	<p>Flame rod supplied. UV scanner adaptors are available. For UV scanners, Eclipse recommends a flame monitoring system that terminates the ignition spark and proves the pilot flame without spark prior to opening the main gas valves.</p> <p>Burners over 5 lineal feet include flame supervision at the far end. If pilot ignition is being used, two flame supervision units are required; one for the pilot and one for the far end. If using direct spark on the main flame, only flame supervision at the far end is required providing that ignition can be accomplished within 15 seconds. (Reference NFPA 5-9.2.2)</p> <p>CGA requires two flame rods on burners over 36" long (914 mm). Use a flame monitoring endplate (see Data 140-6) to mount a second flame rod on the end opposite the gas inlet.</p>		
Materials:	All portions of the burner exposed to flame are cast iron or #321 stainless steel.		
Emissions:	Emissions performance depends not only on the burner, but also other factors such as chamber temperature, chamber design, and heat loading. For estimates of emissions performance in your application, call Eclipse.		
Packaging Options:	Available with complete valve trains and control systems. RAH burners and systems can be supplied mounted on duct sections as specified by the customer. Call Eclipse for information on custom packaged systems.		
Models:	<u>Model</u>	<u>Description</u>	<u>Data Sheet</u>
	RAH	Line-shape	Data 142-1
	TAH-R	"I"-shape	Data 142-2

* Based on parallel air flow. If mounted in a cross flow, then flame will be shorter.

CAUTION: It is dangerous to use any fuel burning equipment unless it is equipped with suitable flame sensing devices and automatic fuel shut-off valves. Eclipse can supply such equipment or information on alternate sources.

Mounting Arrangement

NOTE: The blower and the adjoining duct (shown in the darker shaded areas) are not part of the burner assembly; they must be purchased and installed separately.

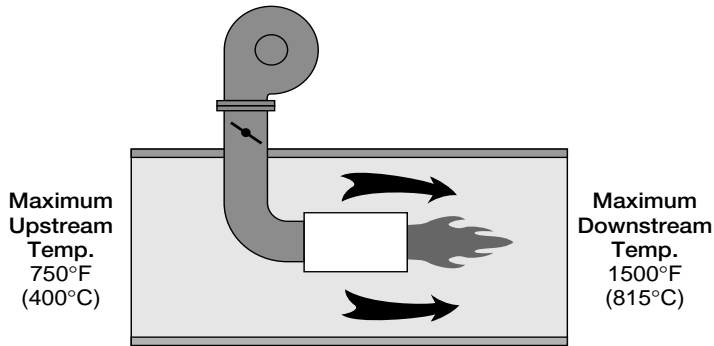

Maximum Upstream Temp. 750°F (400°C)

Maximum Downstream Temp. 1500°F (815°C)

Min./Max. Velocity: 500 to 6000 fpm
2.54 to 30.48 m/s

Optimum Velocity: 1000 to 4000 fpm
5.08 to 20.32 m/s

- Provide at least 3" (76 mm) clearance between burner and top, bottom and sides of the duct.
- Profile plates are not required for good burner operation, but uniform velocity must be maintained for full length of burner. If velocity is not uniform, use profile plates to correct it.

Guidelines for Mounting Arrangement

- Center the burner in the duct.
- Allow a minimum of 46" (1168 mm) from burner to nearest point of possible flame impingement at an input of 1,000,000 Btu/hr. (962 kW/m).
- Support the blower and motor independently of the burner.

Blower Sizing

Blower Volume: Select a blower capable of producing 13,000 cfm per lineal foot of burner.

Blower Pressure: = 2 (Max. Duct Press.) – Min. Duct Press.

Blower Pressure Calculation—Pressure System

Example 1

Max. Duct Press: 30" w.c.

Min. Duct Press: 9" w.c.

Blower Press. = 2 (30") – 9" = 51" w.c.

Example 2

Max. Duct Press: 0.5" w.c.

Min. Duct Press: 0.2" w.c.

Blower Press. = 2 (0.5") – 0.2" = 0.8" w.c.

NOTE: On pressure systems, the blower pressure must be at least 1.5" w.c. more than the **maximum** duct pressure. In Example 2, the blower pressure should be 0.5" + 1.5" = 2.0" w.c.

Blower Pressure Calculation—Suction System

On suction systems, no blower is needed if duct pressure is always –1.5" w.c. or less, and the ratio of lowest to highest pressure is no greater than three.

Example 1

Max. Duct Press: –6" w.c.

Min. Duct Press: –20" w.c.

Since the ratio of lowest pressure to highest is 3.3, a blower is required:

Blower Press. = 2 (–6") – (–20") = 8" w.c.

Example 2

Max. Duct Press: –0.4" w.c.

Min. Duct Press: –0.9" w.c.

Blower Press. = 2 (–0.4") – (–0.9") = 0.1" w.c.

NOTE: On suction systems, the blower pressure must be at least 1.5" w.c. more than the **minimum** duct pressure. In Example 2, the blower pressure should be –0.9" + 1.5" = 0.6" w.c.

Blower Pressure Calculation—Suction-to-Pressure System

Example 1

Max. Duct Press: 2" w.c.

Min. Duct Press: –1.0" w.c.

Blower Press. = 2 (2") – (–1.0") = 5" w.c.

Example 2

Max. Duct Press: 0.5" w.c.

Min. Duct Press: –0.2" w.c.

Blower Press. = 2 (0.5") – (–0.2") = 1.2" w.c.

NOTE: On pressure-to-suction systems, the blower pressure must be at least 1.5" w.c. more than the **maximum** duct pressure. In Example 2, the blower pressure should be 0.5" + 1.5" = 2.0" w.c.

Burner Firing Arrangements

The AH Burner can fire in any direction. Flow through the burner's check valve, however, must be horizontal. A guide for identifying some standard arrangements is shown below.

Be sure to indicate the appropriate number arrangement when ordering. If no arrangement is indicated, No. 1 will be furnished as standard.

Horizontal Firing

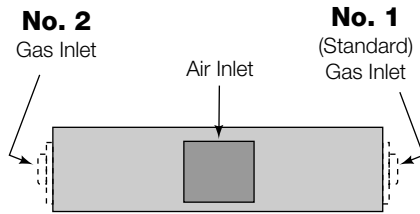

Vertical Firing Up

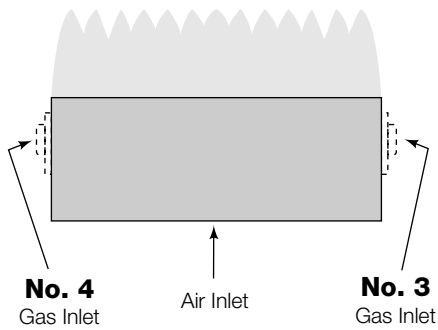

Vertical Firing Down

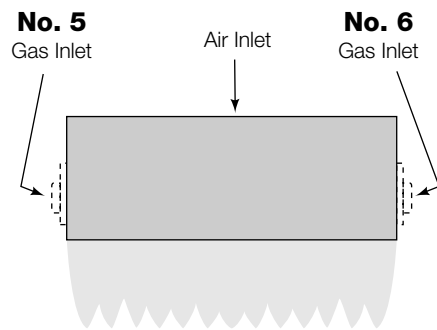

On End Firing

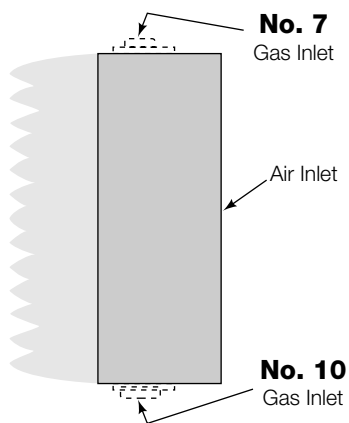

On End Firing

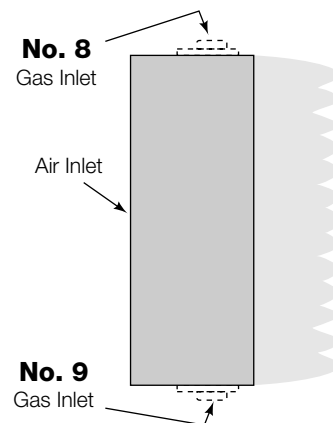

ECLIPSE COMBUSTION